

Il tuo partner per i

# **SISTEMI DI SERRAGGIO e AUTOMAZIONE**



[www.hainbuch.it](http://www.hainbuch.it)

 **Italia**  
**HAINBUCH**  
TECNICA DEL SERRAGGIO



# LA NOSTRA MISSION

Rivoluzioniamo i processi di serraggio



Dal 1951 – azienda a  
conduzione familiare



Più di 1.000 soluzioni  
personalizzate all'anno



150 brevetti  
e numerosi premi



850 dipendenti  
in tutto il mondo



per tutte le lavorazioni



TORNITURA



FRESATURA



RETTIFICA

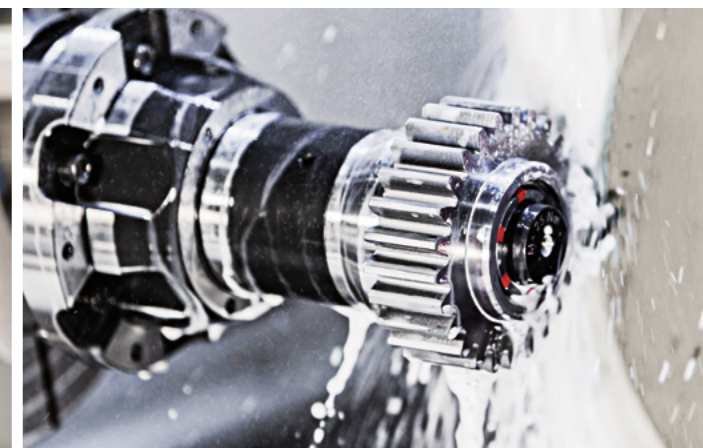

DENTATURA





# HAINBUCH SYSTEM

per una straordinaria flessibilità



Cambio rapido  
< 2 minuti



## Dispositivi di serraggio

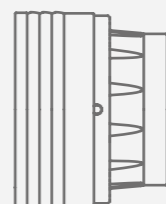

Mandri di bloccaggio

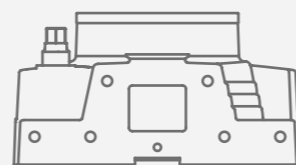

Morse di serraggio

## Elementi di bloccaggio e adattamenti



Pinze di serraggio per bloccaggio esterno

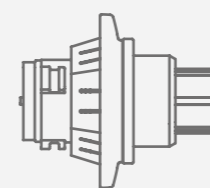

MANDO Adapt  
Adattamento per bloccaggio interno

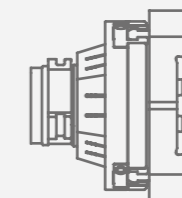

Modulo a griffe  
Adattamento per serraggio a griffe

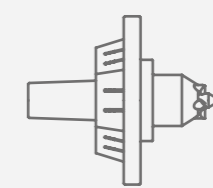

Trascinatore frontale / Cono morse  
Adattamento per serraggio con punta da centro

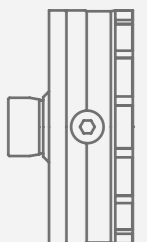

Modulo magnetico  
Adattamento per il bloccaggio magnetico



# MANDRINI A ESPANSIONE

per un solido bloccaggio dall'interno



- Massima precisione di concentricità
- Elevate forze di serraggio per ogni diametro
- Agevole messa a punto
- Accessibilità al pezzo da 5 lati



# SISTEMI DI CAMBIO RAPIDO

per un veloce set-up < 5 min



SENZA centroteX  
≈ 35 MINUTI



CON centroteX  
< 5 minuti



Flangia di adattamento  
alla macchina  
[rimane sempre  
montata]



Flangia di adattamento  
con portapinze

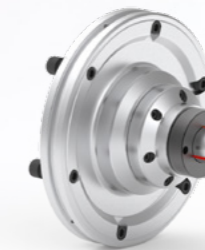

Flangia di adattamento  
con mandrino a  
espansione



Flangia di adattamento  
con autocentrante a griffe

- Interfacce di cambio rapido standardizzate
- Ripetibilità  $\leq 3 \mu\text{m}$  senza messa a punto
- Le parti di ricambio possono essere predisposte all'esterno della macchina





# SOLUZIONI PERSONALIZZATE

per essere pronti ad ogni sfida



- Oltre 1.000 soluzioni personalizzate all'anno
- > 55 ingegneri progettisti e il nostro team di R&D sviluppano soluzioni speciali su misura per soddisfare ogni tipo di richiesta
- Il 50% dei nostri ordini sono per soluzioni personalizzate

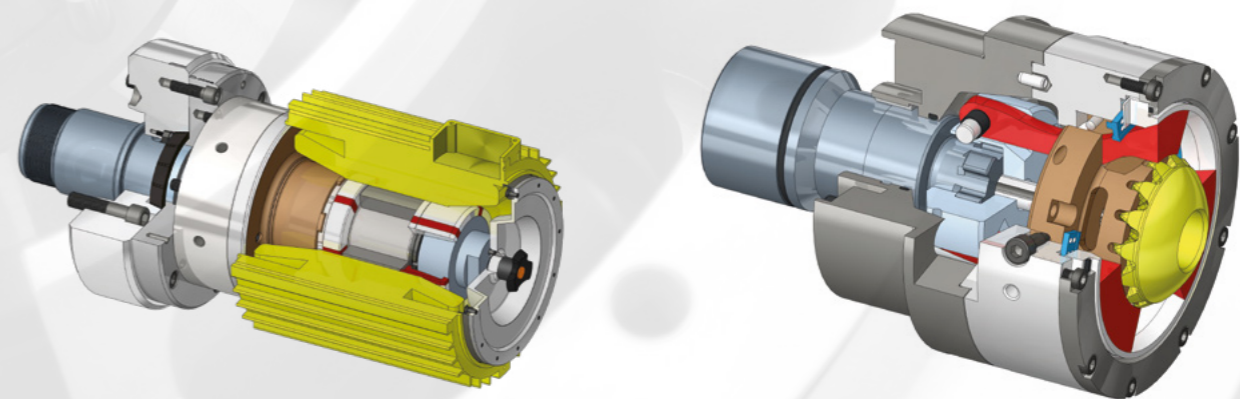



# AUTOMAZIONE

Linea AC - cambio automatico

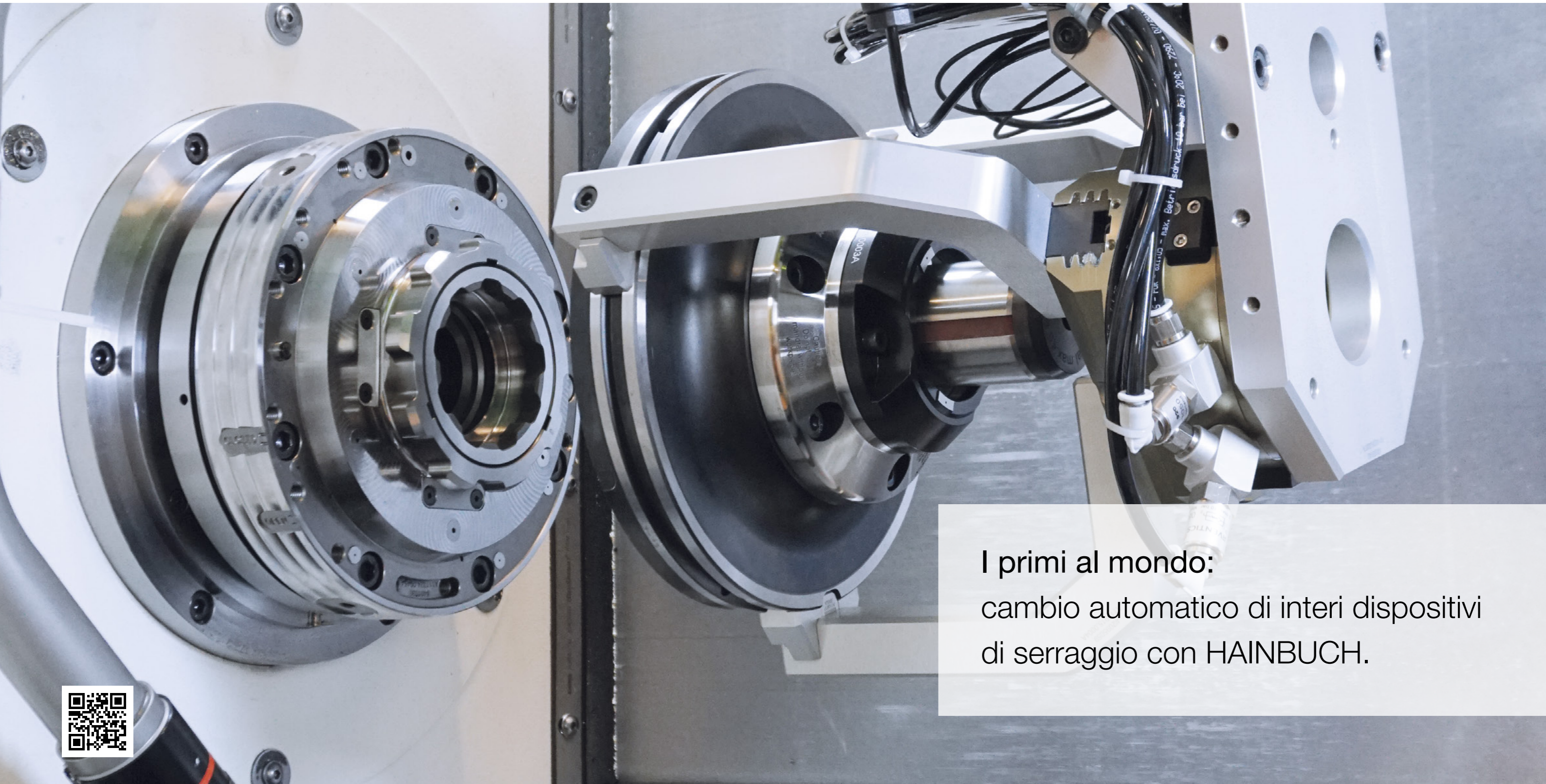

I primi al mondo:  
cambio automatico di interi dispositivi  
di serraggio con HAINBUCH.





# CONTATTI LA NOSTRA RETE SERVICE MONDIALE

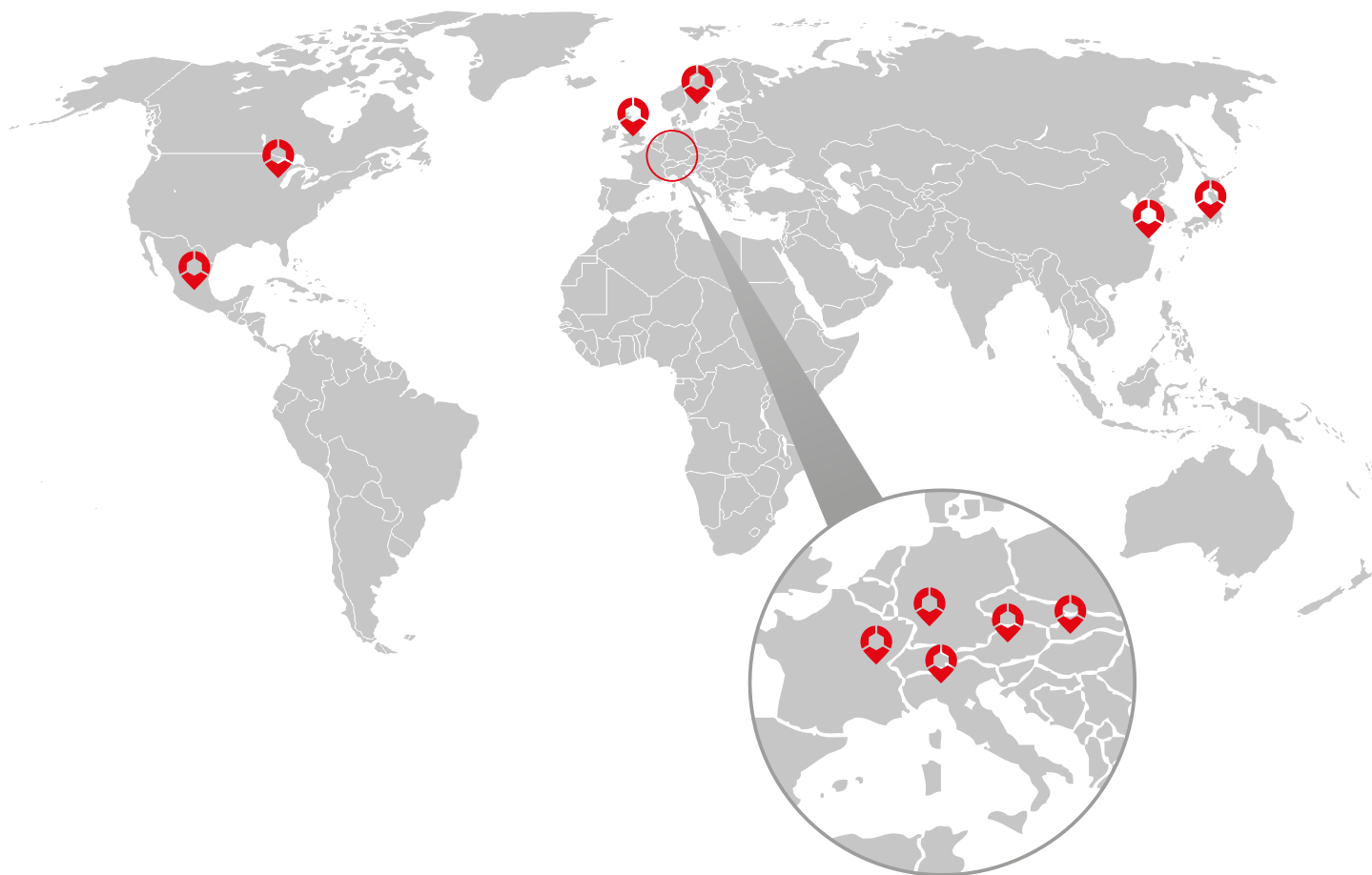

Scopri le nostre filiali e gli agenti HAINBUCH su [www.hainbuch.it](http://www.hainbuch.it)



HAINBUCH Italia srl · TECNICA DEL SERRAGGIO  
Via Caduti di Nassiriya 5 · 22063 Cantù [CO] · Italia  
Tel. +39 0313355351 · [info@hainbuchitalia.it](mailto:info@hainbuchitalia.it) · [www.hainbuch.it](http://www.hainbuch.it)